



AZ
AMYZA

GENERAL TRADING AND CONTRACTING

Transforming Spaces with Elegance, Quality & Innovation

OVERVIEW

AMYZA GENERAL TRADING AND CONTRACTING is a leading supplier and distributor of premium sanitaryware, bathroom fittings, plumbing accessories, and building material solutions in the UAE. Established with a commitment to quality, innovation, and customer satisfaction, the company serves residential, commercial, hospitality, and industrial sectors with a comprehensive range of products from globally recognized brands.

With a strong distribution network and strategic partnerships, the company has built a reputation for reliability, competitive pricing, and timely delivery across the UAE and GCC markets.

AMYZA GENERAL TRADING AND CONTRACTING is Also, a UAE-based technical services and contracting company providing reliable maintenance, fit-out, renovation, MEP, and general contracting solutions for residential, commercial, and industrial projects. Established with a commitment to quality workmanship, safety, and customer satisfaction, we deliver efficient and cost-effective technical solutions tailored to the needs of modern buildings and infrastructure.

ABOUT US

AMYZA GENERAL TRADING AND CONTRACTING specializes in the trading and distribution of sanitaryware products, bathroom accessories, faucets, plumbing materials, tiles, Modular Kitchen Designing and Execution, and related building materials. We cater to contractors, developers, architects, interior designers, retailers, and end users by offering high-quality products that combine functionality, durability, and modern design.

Our goal is to provide complete bathroom and plumbing solutions under one roof while maintaining international quality standards and exceptional customer service.

Industry examples in the UAE commonly position themselves as one-stop sanitaryware and plumbing solution providers serving both retail and project markets. We are also specializing in technical services, maintenance, renovation, interior fit-out, and contracting works across the UAE. We work closely with property owners, contractors, developers, facility management companies, and businesses to provide dependable project execution and maintenance support.

Our team is committed to delivering projects with professionalism, attention to detail, and timely completion while maintaining high standards of safety and quality.

VISION AND MISSION

VISION

To become one of the most trusted and preferred sanitaryware trading and contracting companies in the UAE and GCC region by delivering superior products, innovative solutions, and excellent customer service and also to become a trusted technical services and contracting company in the UAE recognized for quality workmanship, reliability, and customer satisfaction.

MISSION

- To provide premium-quality sanitaryware and plumbing solutions at competitive prices.
- To build long-term relationships with customers through trust and reliability.
- To ensure timely delivery and professional after-sales support.
- To continuously expand our product portfolio to meet evolving market trends and customer requirements.
- To provide professional technical and contracting services through skilled manpower, quality execution, and efficient project management while maintaining safety and operational excellence.

OUR PRODUCTS

WE OFFER A WIDE RANGE OF PRODUCTS INCLUDING:

- Sanitaryware
- Bathroom fittings & accessories
- Faucets & mixers
- Wash basins & vanity units
- Water closets & bidets
- Bathtubs & shower systems
- Kitchen sinks & accessories
- Plumbing materials
- Pipes & fittings
- Water heaters & pumps
- Tiles & building materials
- Stainless Steel Customized Shower drains and
Lenier Drains

OUR SERVICES

SUPPLY SERVICES

- Wholesale & retail supply
- Project supply solutions
- Customized product sourcing
- Logistics & delivery support
- Technical consultation
- After-sales service

TECHNICAL SERVICES

- Electrical Works
- Plumbing Works
- Carpentry & Wood Works
- Painting Services
- Ceiling & Partition Works
- Tiling & Flooring
- Swimming pool work

CONTRACTING SERVICES

- General Maintenance
- Villa & Office Renovation
- Interior Fit-Out Works
- Gypsum & False Ceiling
- Waterproofing
- Civil Works
- MEP Services

WHY CHOOSE US ?

QUALITY PRODUCTS

We partner with trusted international and regional brands to ensure superior quality and long-lasting performance.

COMPETITIVE PRICING

Our strong supplier network allows us to offer cost-effective solutions without compromising quality.

PROFESSIONAL TEAM

Our experienced sales and support team provides expert guidance for residential and commercial projects.

TIMELY DELIVERY

We maintain efficient inventory and logistics systems to ensure prompt delivery across the UAE.

CUSTOMER SATISFACTION

We prioritize customer relationships by offering personalized service and reliable support.

Customer service, strong inventory management, and project support are consistently highlighted as differentiators among leading UAE sanitaryware suppliers.

INDUSTRIES WE SERVE & OUR STRENGTHS

INDUSTRIES WE SERVE

- Residential Projects
- Commercial Buildings
- Hotels & Hospitality
- Retail Showrooms
- Government Projects
- Industrial Facilities
- Construction & Infrastructure Projects

OUR STRENGTHS

- Wide product range
- Strong supplier partnerships
- Experienced management
- Reliable supply chain
- Modern showroom facilities
- Commitment to quality and innovation

BRANDS WE DEAL IN

We deal with internationally recognized sanitaryware and bathroom brands to ensure premium quality and modern design solutions for our customers. Leading sanitaryware traders in the UAE frequently partner with brands such as Jaquar, Sanit, Sanipex, Vado, Italian Standard, RAK Ceramics and other global bathroom solution providers.

HEALTH, SAFETY & QUALITY

We are committed to maintaining the highest standards of quality, safety, and environmental responsibility in all our operations and business practices.

HEALTH, SAFETY & ENVIRONMENT (HSE)

Safety is an integral part of our operations. We are committed to maintaining a safe and healthy workplace for our employees, clients, and partners. Our HSE practices include:

- Safety training programs
- Proper use of PPE
- Site risk assessments
- Compliance with local authority regulations
- Regular safety inspections

QUALITY POLICY

We are committed to delivering products and services that meet customer expectations and comply with applicable standards and regulations. Our quality objectives include:

- Continuous improvement
- Client satisfaction
- Reliable workmanship
- Timely project execution
- High-quality materials and services

OUR CLIENTS

We proudly serve:

- Homeowners
- Contractors
- Consultants
- Real estate developers
- Facility management companies
- Government organizations
- Commercial establishments

MAJOR PROJECTS

RESIDENTIAL PROJECTS

- Villa Tiles, plumbing & sanitary installations
- Bathroom renovation projects

COMMERCIAL PROJECTS

- Construction Projects Supply of Tiles and Installation
- Retail shop fit-outs
- Office renovation works

HOSPITALITY PROJECTS

- Hotel sanitaryware supply
- Restaurant plumbing and maintenance works



AMYZA

SANITARYWARE BRANDS

PREMIUM COLLECTION

JAQUAR | SANIT | VADO | SANIPEX | NOURK | ITALIAN STANDARD





CONTENTS

01	JACUAR.....	03
02	SANIT.....	05
03	VADO.....	07
04	SANIPEX.....	09
05	NOURK.....	11
06	ITALIAN.....	13



JAQUAR

Jaquar is a leading Indian bathroom solutions brand established in 1960, known for premium sanitaryware, faucets, showers, and wellness systems. With a focus on innovation, quality, durability, and modern design, Jaquar delivers advanced and water-efficient solutions for residential, commercial, and hospitality projects.

Present in over 55 countries, Jaquar is trusted globally for its performance, luxury, and elegant design standards. The brand continues to grow through world-class quality, modern technology, and customer-focused solutions.



Jaquar

PREMIUM BATHROOM

WASH BASIN



FAUCET



SHOWER SYSTEM



WESTERN TOILET



BATHTUB



BATHROOM ACCESSORIES





ROCA GROUP
Competence Center



SANIT is a trusted German bathroom solution brand known for its advanced sanitary technology, concealed cistern systems with German cable technology flushing solutions, and modern bathroom innovations. With a strong focus on quality, durability, and engineering excellence, SANIT delivers reliable and efficient products designed for residential, commercial, and hospitality spaces.

The brand is recognized for combining smart functionality with modern aesthetics to create comfortable and hygienic bathroom environments. Trusted globally for performance & innovation, SANIT continues to provide high-quality solutions that enhance modern bathroom design and everyday living.

CHOOSE THE SOLUTION WHICH BEST SUITS YOUR INSTALLATION



INEO PLUS 450
90.743.00..XXXX
Standard Height
Concealed Cistern
with frame.
Height: 1120 mm
Width: 450 mm



INEO 80 PLUS
90.804.00..0000
Slim Concealed
Cistern with frame.
Height: 1120 mm
Width: 635 mm



INEO FRONTOP 820
90.745.00..T000
Low Height
Concealed Cistern
with frame.
Height: 820 mm
Width: 525 mm



Concealed cistern INEO
95.720.00..0000
Concealed Cistern
for floor-standing WCs.
Height: 735 mm
Width: 445 mm

PROJECT CISTERNS (ECONOMY MODELS)

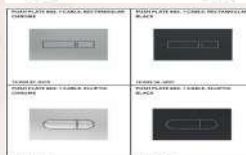





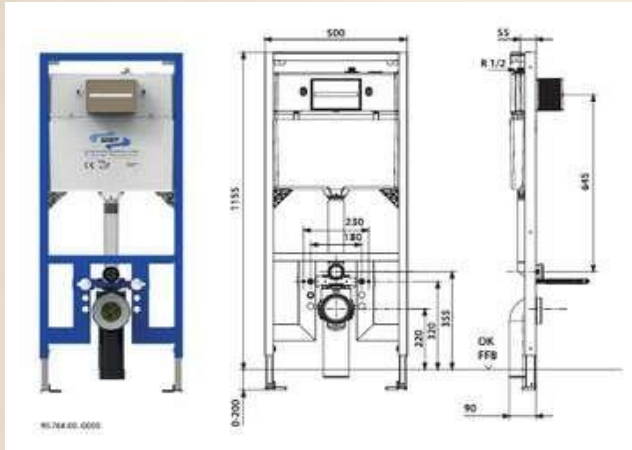

SANITARY SOLUTIONS





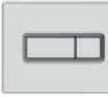

SANIT WALL-HUNG TOILET SYSTEM



SANIT FLUSH PLATES

 <p>16.701.01.0000 (WHITE) 16.701.93.0000 (MATT CHROME) 16.701.81.0000 (CHROME)</p>	 <p>16.703.01.0000 (WHITE) 16.703.93.0000 (MATT CHROME) 16.703.81.0000 (CHROME) 16.703.00.0000 (STAINLESS STEEL)</p>	 <p>16.706.01.0000 (WHITE) 16.706.93.0000 (MATT CHROME) 16.706.81.0000 (CHROME)</p>
 <p>16.707.01.0000 (WHITE) 16.707.93.0000 (MATT CHROME) 16.707.81.0000 (CHROME)</p>	 <p>16.708.01.0000 (WHITE) 16.708.81.0000 (CHROME)</p>	 <p>16.745.01.0004 (WHITE) 16.745.81.0004 (CHROME)</p>

SANIT GLASS & STEEL FLUSH PLATES

 <p>16.720.01.0000 (WHITE) 16.721.01.0000 (BLACK/WHITE)</p>	 <p>16.720.C2.0000 (WHITE) 16.721.C2.0000 (BLACK)</p>	 <p>16.726.01.0000 (WHITE) 16.726.02.0000 (BLACK) 16.726.81.0000 (CHROME) 16.721.93.0000 (MATT CHROME)</p>
 <p>16.732.00.0000</p>	 <p>16.724.81.0000 (CHROME) 16.724.00.0000 (STAINLESS STEEL) 16.724.00.0004 (STAINLESS STEEL BRUSHED) 16.724.00.0003 (STAINLESS STEEL POLISHED)</p>	 <p>16.735.00.0002 (WHITE)</p>





SANIT Wall & Squat Cistern

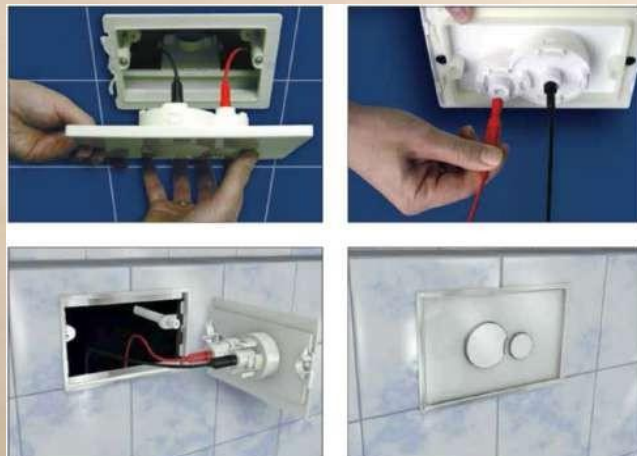

SANIT FUEL VALVE MECHANISM



SANIT VALVE COMPONENTS

<p>FILL VALVES / FLUSH VALVE</p>  <p>S10 G 3/8 x 30</p> <p>25.001.00.0000</p>	 <p>FLUSH MECHANISM INEO</p> <p>03.982.00.0000</p>	 <p>FLUSH VALVE CONCEALED CISTERN 8 CM</p> <p>05.076.00.0000</p>
 <p>MECHANISM VERTICAL INLET</p> <p>93.606.81.0001</p>	 <p>MECHANISM HORIZONTAL INLET</p> <p>93.606.81.0014</p>	

VADO

VADO is a premium bathroom brand from the United Kingdom, established in 2005. The brand is known for its luxury bathroom fittings, innovative shower systems, stylish faucets, and modern bathroom accessories designed with high-quality engineering and contemporary European aesthetics.

VADO focuses on combining elegant design, advanced technology, and long-lasting performance to create sophisticated bathroom solutions for residential, hospitality, and commercial spaces. With a strong reputation for quality and innovation, the brand continues to deliver modern bathroom products that enhance comfort, functionality, and style.



VADO

DESIGNER FAUCETS & ACCESSORIES

BASIN MIXER



SHOWER SYSTEM



FLUSH PLATE



ACCESSORIES



BASIN



FLOOR DRAIN



SANIPEX

SANIPEX is a premium bathroom and plumbing solutions brand from the United Arab Emirates, established in 1995. The brand is known for high-quality sanitaryware, faucets, shower systems, plumbing products, and modern bathroom solutions with stylish and innovative designs.

SANIPEX combines luxury, durability, and advanced engineering to create elegant bathroom spaces for residential and commercial projects. With a strong reputation across the Middle East, the brand continues to deliver modern and reliable bathroom solutions that enhance comfort and functionality.



SANIPEX GROUP

SANIPEX

COMPLETE SANITARYWARE & PLUMBING

TOILET



SHOWER SYSTEM



FLUSH PLATE



ACCESSORIES



BASIN



FLOOR DRAIN



NOURK

NOURK is a sanitary ware and bathroom products brand from Spain. The company specializes in products like bathtubs, basins, water mixers, WC units, and bathroom vanity cabinets. Its headquarters are located in Alcoy, Spain, and the brand focuses on modern bathroom solutions with ISO-certified quality products.

The brand was started in 2021 and operates in the manufacturing industry. NOURK has grown as an international bathroom and sanitary ware brand, supplying products to different global markets while promoting stylish designs, durability, and modern technology in bathroom fittings.



NOURK

NOURK

BASINS & FAUCETS

ONE PIECE TOILET



NOURK BASIN & FAUCET SET



LED MIRROR



CP FAUCET



TOWEL RACK



SHOWER SYSTEM



ITALIAN STANDARD

Italian Standard is a premium sanitaryware and bathroom solutions brand known for modern European-inspired designs, quality craftsmanship, and stylish bathroom products. The brand focuses on delivering elegant sanitaryware, faucets, showers, and bathroom accessories with a combination of durability, innovation, and luxury finishing.

The brand is associated with Italian design standards and modern bathroom aesthetics, offering products that match contemporary living styles. Italian Standard has built a reputation for sophisticated designs, functional performance, and high-quality bathroom solutions trusted in residential and commercial projects.



ITALIAN[®]
STANDARD

ITALIAN[®]

SMART BATHROOM SOLUTIONS

BIDET



RAIN SHOWER SET



ONE PIECE TOILET



WALL HUNG URINAL



FREESTANDING BATHTUB



**CONCEALED FLUSH
TANK SYSTEM**



Contact Us



AMYZA

GENERAL TRADING AND CONTRACTING.

Transforming Spaces with Elegance, Quality & Innovation

Rawda, Ajman, UAE

Phone: +971-507404335

Email: amyza.gtc@gmail.com

Website: www.amyzagtc.com